

EN - For pricing and availability in your local country please visit one of the below links:

DE - Informationen zu Preisen und Verfügbarkeit in Ihrem Land erhalten Sie über die unten aufgeführten Links:

FR - Pour connaître les tarifs et la disponibilité dans votre pays, cliquez sur l'un des liens suivants:

[MCL053SWC-WH1](#)

EN

This Datasheet is presented by
the manufacturer

DE

Dieses Datenblatt wird vom
Hersteller bereitgestellt

FR

Cette fiche technique est
présentée par le fabricant

LED

Pure White, 5mm

multicomp **PRO**

RoHS
Compliant



Specifications:

Dice material	: InGaN
Emitted colour	: White
Lens colour	: Water Clear
Peak wavelength	: $\lambda = 0.31$
Viewing angle	: 16°
Luminous intensity (IV)	: 9,000mcd

Absolute Maximum Ratings ($T_a = 25^\circ\text{C}$)

Reverse Voltage	5V
Reverse Current	10 μ A ($V_R = 5V$)
Electrostatic Discharge (ESD)	200V
Operating Temperature Range	-40°C to 85°C
Storage Temperature Range	-40°C to 100°C
Lead Soldering Temperature Range 1.6mm (1/16 inch) from body	260°C for 5 Seconds

Electrical/Optical Characteristics at $T_a = 25^\circ\text{C}$

Parameter	Symbol	Minimum	Typical	Maximum	Unit	Test
Luminous Intensity	IV	4,500	9,000	13,500	mcd	IF = 20mA
Viewing Angle	2 θ 1/2	-	16	-	degrees	
Peak Emission Wavelength	X	-	0.29	-	nm	-
Dominant Wavelength	Y	-	0.31	-		-
Spectral Line Half-Width	$\Delta\lambda$	-	-	-		-
Forward Voltage	VF	2.7	3.4	4	V	IF = 20mA
Power Dissipation	Pd	-	-	85	-	-
Peak Forward Current (Duty 1/10 at 1KHz)	IF (Peak)	-	-	100	-	-
Recommended Operating Current	IF (Rec)	-	20	-	mA	-

LED

Pure White, 5mm

White Typical Electrical Optical Characteristics Curves ($T_a = 25^\circ\text{C}$ Ambient Temperature Unless Otherwise Noted)

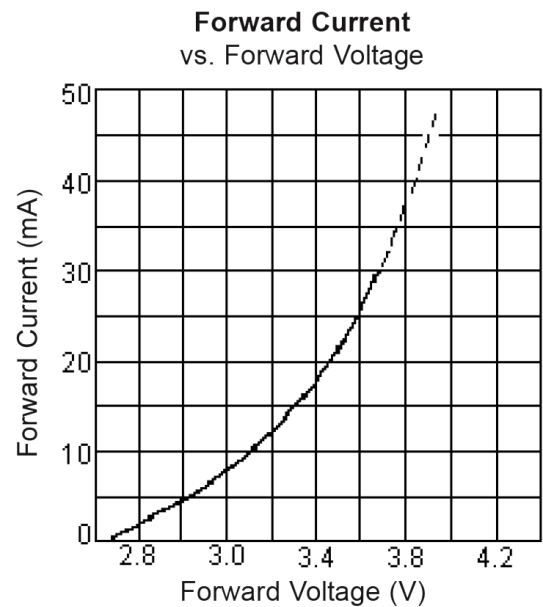
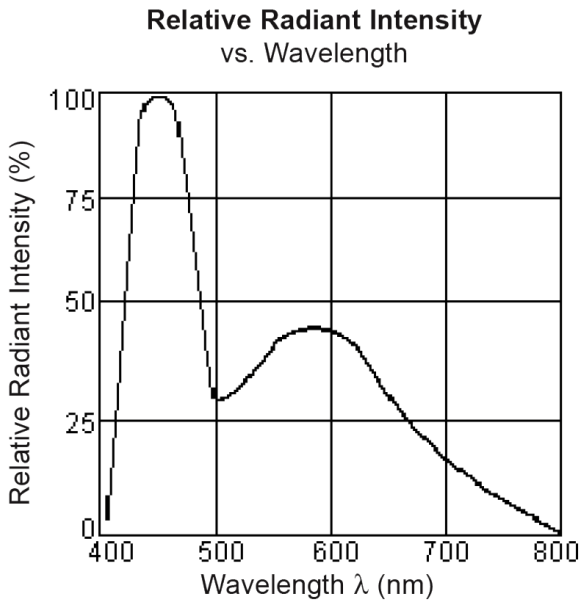

White Typical Electrical Optical Characteristics Curves ($T_a = 25^\circ\text{C}$ Ambient Temperature Unless Otherwise Noted)

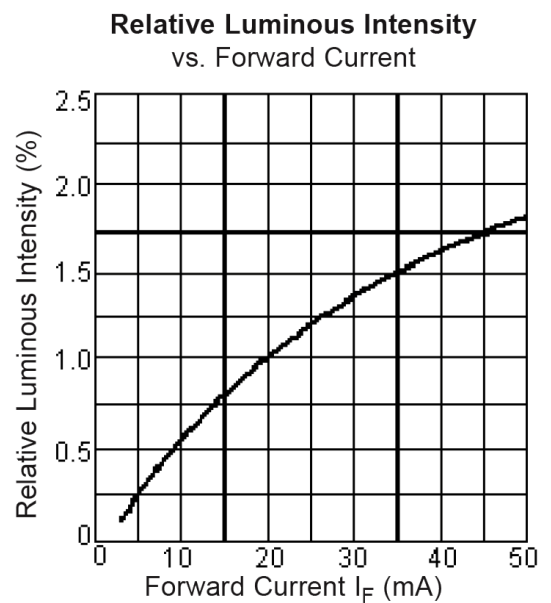
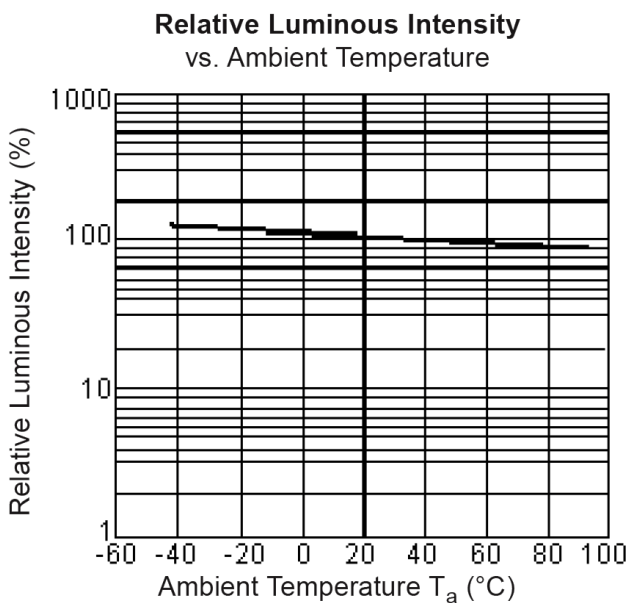

LED

Pure White, 5mm

Forward Current Derating Curve

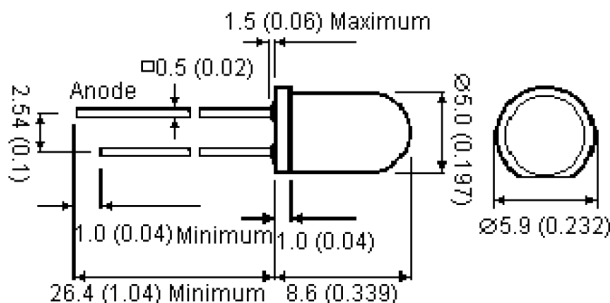
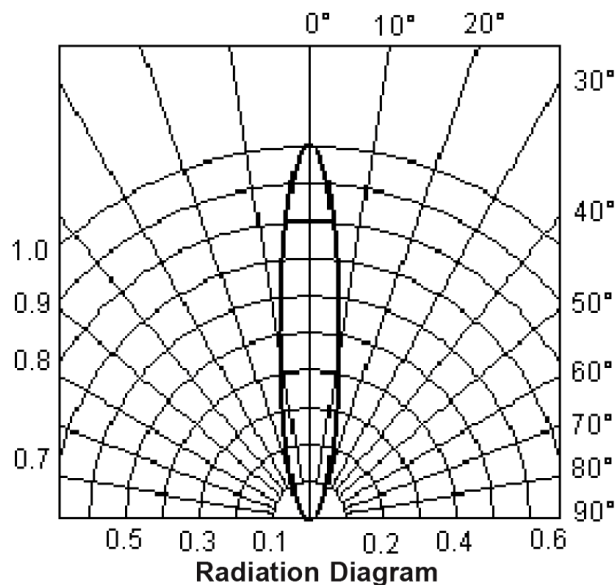
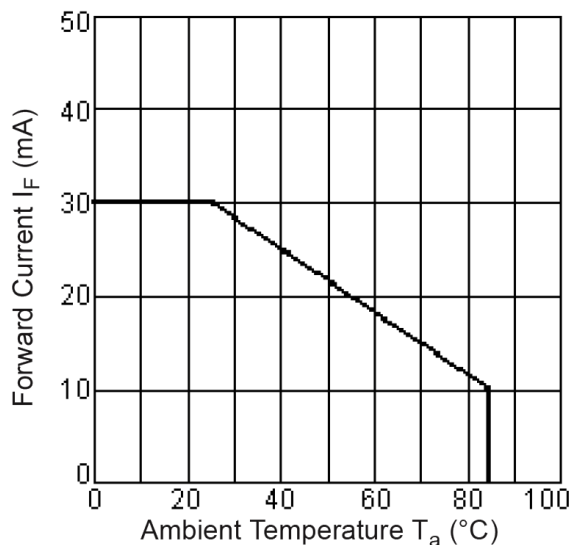

Dimensions : Millimetres (Inches)

Part Number Table

Description	Part Number
LED, 5mm, 16°, Pure White	MCL053SWC-WH1

Important Notice : This data sheet and its contents (the "Information") belong to the members of the AVNET group of companies (the "Group") or are licensed to it. No licence is granted for the use of it other than for information purposes in connection with the products to which it relates. No licence of any intellectual property rights is granted. The Information is subject to change without notice and replaces all data sheets previously supplied. The Information supplied is believed to be accurate but the Group assumes no responsibility for its accuracy or completeness, any error in or omission from it or for any use made of it. Users of this data sheet should check for themselves the Information and the suitability of the products for their purpose and not make any assumptions based on information included or omitted. Liability for loss or damage resulting from any reliance on the Information or use of it (including liability resulting from negligence or where the Group was aware of the possibility of such loss or damage arising) is excluded. This will not operate to limit or restrict the Group's liability for death or personal injury resulting from its negligence. Multicomp Pro is the registered trademark of Premier Farnell Limited 2019.



element14

EN - For pricing and availability in your local country please visit one of the below links:

DE - Informationen zu Preisen und Verfügbarkeit in Ihrem Land erhalten Sie über die unten aufgeführten Links:

FR - Pour connaître les tarifs et la disponibilité dans votre pays, cliquez sur l'un des liens suivants:

[MCL053SWC-WH1](#)

EN

This Datasheet is presented by
the manufacturer

DE

Dieses Datenblatt wird vom
Hersteller bereitgestellt

FR

Cette fiche technique est
présentée par le fabricant